



Quality Access Doors- FAST!

SUBMITTAL/TECHNICAL DATA SHEET

SKU: **BAG-S-70**

SINGLE LEAF ROOF SCUTLE



SPECIFICATIONS

01. Frame with capflashing (Corners full welded)
 - S-20 - 14 gauge P.B. Galv. steel
 - S-40 - 14 gauge P.B. Galv. steel
 - S-50 - 11 gauge aluminum
 - S-90 - 14 gauge type 304 stainless steel
02. Pintle hinge
03. Gasket (All around cover)
04. Cover gauge
 - S-20 - 14 gauge P.B. Galv. steel
 - S-40 - 11 gauge aluminum
 - S-50 - 11 gauge aluminum
 - S-90 - 14 gauge type 304 stainless steel
5. Cover liner
 - S-20 - 22 gauge P.B. Galv. steel
 - S-40 - 18 gauge aluminum
 - S-50 - 18 gauge aluminum
 - S-90 - 22 gauge type 304 stainless steel
06. Spring lifting mechanism
07. 1" rigid fiberboard insulation
08. Slam latch
09. Inside and outside handles with padlock hasps
10. Arm guide bracket
11. 1" thick fiberglass cover insulation
12. Hold open arm with Red vinyl grip
13. Neoprene gasket
14. Lock strike & padlock hasp
15. Bilclip® flashing system

SHOP FINISH:

- STEEL: Red oxide primer
- ALUMINUM: Mill finish
- HARDWARE: Non-corrosive materials (Unless otherwise specified)
- STAINLESS STEEL: Beadblast finish type 316 s/s hardware

This product may be installed on either a flat or sloping roof. When installed on a slope, the hinge side must run parallel with the slope. If slope exceeds 30°, advise factory for modification.

For a complete list of options visit www.BestAccessDoors.ca

QTY	TYPE	METAL
<input type="checkbox"/>	S-20	Steel cover/Steel frame
<input type="checkbox"/>	S-40	Alum. Cover/Steel frame
<input type="checkbox"/>	S-50	Alum. Cover/Alum. Frame
<input type="checkbox"/>	S-90	Stls. stl. cover/Stls. stl. frame

TYPE E SIZE 3'-0" X 2'-6" (WIDTH X HEIGHT)

DIMENSIONS AND APPEARANCE

>> CLICK TO VIEW ADDITIONAL DETAILS AND PRICING <<

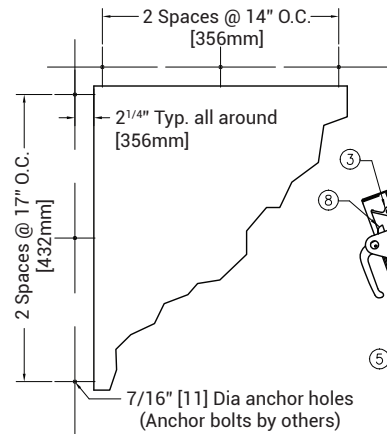
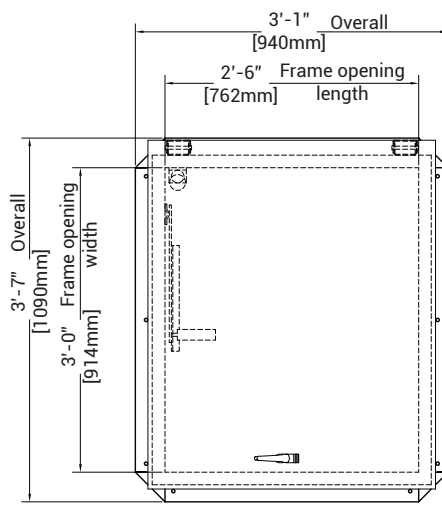

ANCHOR HOLE LAYOUT

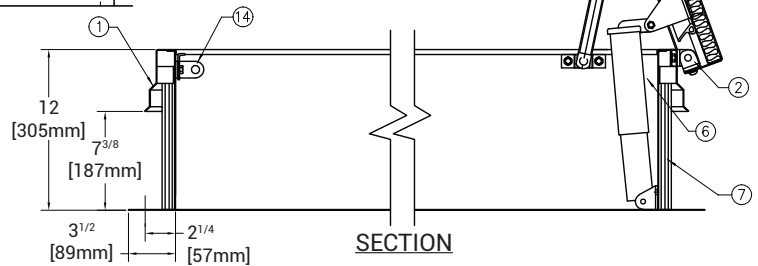
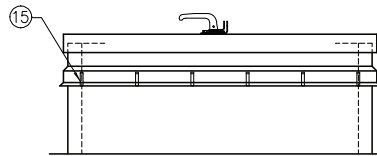

SECTION

MIAMI-DADE PRODUCT APPROVED (NOA NO. 19-1029.10) MEETING LARGE AND SMALL MISSILE IMPACT REQUIREMENTS FLORIDA PRODUCT APPROVAL #FL15110

TYPE: S-20 AND S-50 ONLY

PROJECT DATA

Custom Sizes Available - Fast!

Scan or Click



BEST ACCESS DOORS

To view Pricing and Additional Product Info.

PROJECT NAME :	QTY	W	H	OPTIONS
ARCHITECT :				
DEALER :				
CONTRACTOR :				
LOCATION :	SPECIAL INSTRUCTIONS :			
DATE :				
TAGGING INSTRUCTIONS :	SUBMITTAL APPROVAL : (signature or stamp)			

TELEPHONE:
1-800-483-0823
FAX:
1-888-828-6021

385 WILSON STREET EAST,
SUITE 302
ANCASTER, ON, L9G 2C1
CANADA



WEBSITE:
www.BestAccessDoors.ca
E-MAIL:
info@bestaccessdoors.ca