



Quality Access Doors- FAST!

SUBMITTAL/TECHNICAL DATA SHEET

SKU: **BAG-Q-3**

SINGLE LEAF ACCESS DOOR



SPECIFICATIONS

01. 1/4" x 3" x 3" Steel angle frame
02. 1/4" Steel diamond plate cover
03. Torsion/Cam operating mechanism
04. Standard slam lock
05. Removable square key wrench
06. Automatic hold open arm with Red vinyl grip
07. 3/8" Dia. steel anchor strap
08. 3/8" x 3/4" Steel cover support bar (3 Sides)
09. Steel cast hinges
10. Lock strike
11. Guide arm (If req'd)

SHOP FINISH:

STEEL: Red oxide primer
HARDWARE: Non-corrosive materials
(Unless otherwise specified)

Reinforced for 150 Lbs. Per Sq. Ft. (732 KG. Per Sq. Meter) live load

INSTALLER NOTES:

A. Use caution. Cover is spring loaded. Do not remove safety shipping bolt until unit is to be installed and in normal horizontal operating position.

B. Before anchoring in place open and close door. Check to see that the door in the closed position rests on the frame all around. If not, shim under the frame at the proper corner.

DIMENSIONS AND APPEARANCE

>> CLICK TO VIEW ADDITIONAL DETAILS AND PRICING <<

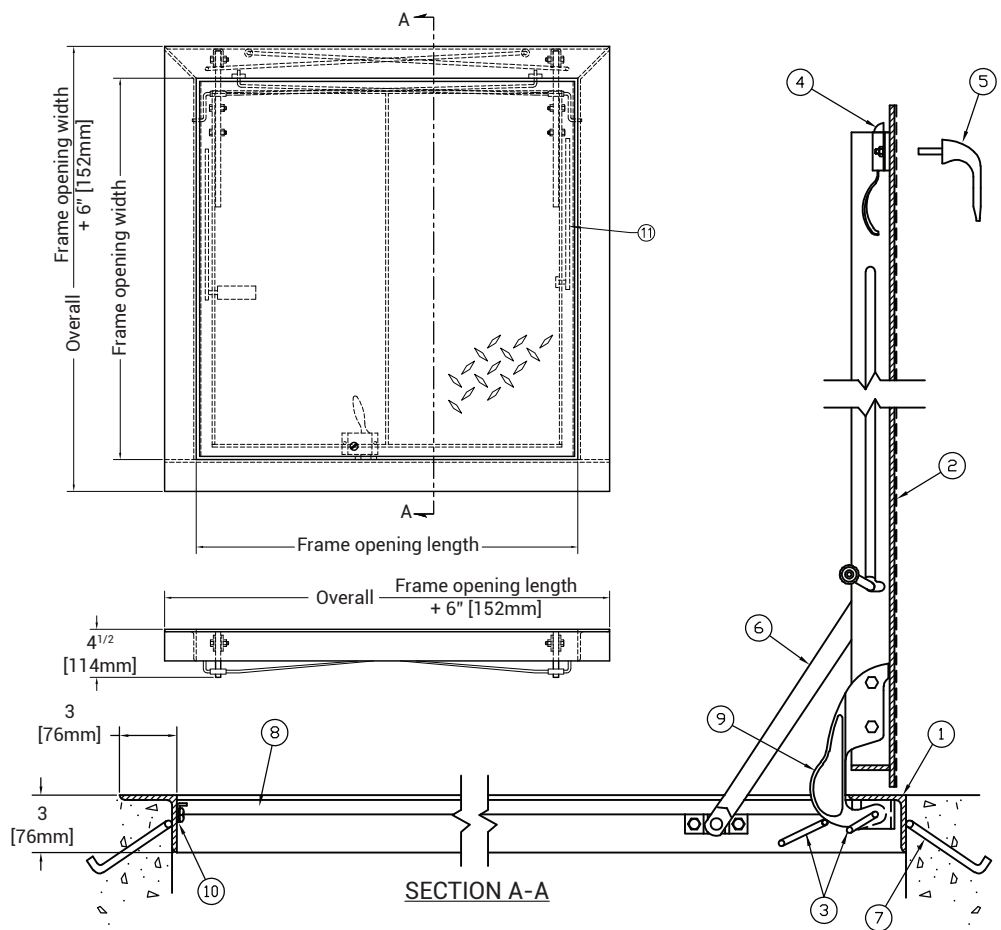

For a complete list of options visit www.BestAccessDoors.ca

QTY	TYPE	SIZE WIDTH X LENGTH
█	Q-1	2'-0" X 2'-0" [610mm] X [610mm]
█	Q-2	2'-6" X 2'-6" [762mm] X [762mm]
█	Q-3	2'-6" X 3'-0" [762mm] X [914mm]
█	Q-4	3'-0" X 3'-0" [914mm] X [914mm]

PROJECT DATA

Custom Sizes Available - Fast!

Scan or Click



To view Pricing and Additional Product Info.

PROJECT NAME :	QTY	W	H	OPTIONS
ARCHITECT :				
DEALER :				
CONTRACTOR :				
LOCATION :	SPECIAL INSTRUCTIONS :			
DATE :				
TAGGING INSTRUCTIONS :	SUBMITTAL APPROVAL : (signature or stamp)			

TELEPHONE:
1-800-483-0823
FAX:
1-888-828-6021

385 WILSON STREET EAST,
SUITE 302
ANCASTER, ON, L9G 2C1
CANADA

WEBSITE:
www.BestAccessDoors.ca
E-MAIL:
info@bestaccessdoors.ca